

Pinch Weld Scraper

9CJ3106

3/4"



KT NO.	inch	mm	inch	mm	kg	ctn / pc
9CJ3106	3/4	19	6-1/2	168	75	24 / 144

Multi Purpose Single Edge Razor Scraper

9CJ61-40

- Ideal for scraping labels and decals
- Comfortable TPR handle for maximum grip
- Accepts all standard single edge razor blades



KT NO.	inch	mm	inch	mm	kg	ctn / pc
9CJ61-40	1-1/2	40	9	235	145	6 / 72

Stainless Steel Pinch Weld Scraper Set

9CJ033



3 PC.

Contents

kg 0.26 ctn / pc 1 / 24



9CJ3104



9CJ3105



9CJ3106

Mini Panel Removal Set

9CI016

- Easy to remove small trim items and panels with slim profile
- Made from impact resistant high quality nylon
- Applicable: Air vents, door panels, door locks, dash trim, internal fittings, etc.

kg 0.30 ctn / pc 12 / 48

6 PC.



Long Nose Clamp

9CD14

- Drop forged chrome molybdenum alloy steel for maximum strength
- Jaw width : 32mm
- 3 Ton straight pulling capacity

kg 1.83 ctn / pc 1 / 10

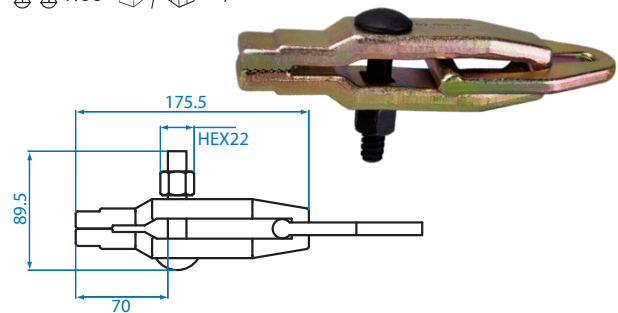

Large Pull Clamp With Top Pull

9CD21

- Drop forged chrome molybdenum alloy steel for maximum strength
- Jaw width : 37mm
- Two-way pull operation
- Dual self-tightening serrated jaws for a positive grip
- Capacity : 3 ton (straight way), 2 ton (cross way)

kg 2.45 ctn / pc 1 / 6

